

woellner-MagTec.
Zuverlässig. Robust.

Electromagnets and components for industrial applications

Chronology of the "woellner-MagTec":

- 2003 Foundation under the name "Mixed-ProduCTS"
- 2010 Sale of "Mixed-ProduCTS "
- 2010 Research and development until year 2014
- 2015 Opening of the "MDRI-Magnetic Devices & Research for Industries GmbH"
- 2017 Change in company structure of „MDRI“
 - Adrian Woellner leaves the company "MDRI"
- 2017 Official refoundation of "woellner-MagTec."
 - International cooperation with customers/companies
- 2018 Expansion to the divisions "woellner-SensorTec." and "woellner-IndukTec."
- 2020 Close cooperations and partnerships with domestic companies

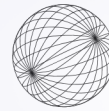

Mission of "woellner-MagTec.":

- Solving complex problems on magnetic level
- Conception and development of electromagnets and magnets also customer-specific
- Preparation of feasibility studies
- Prototype construction

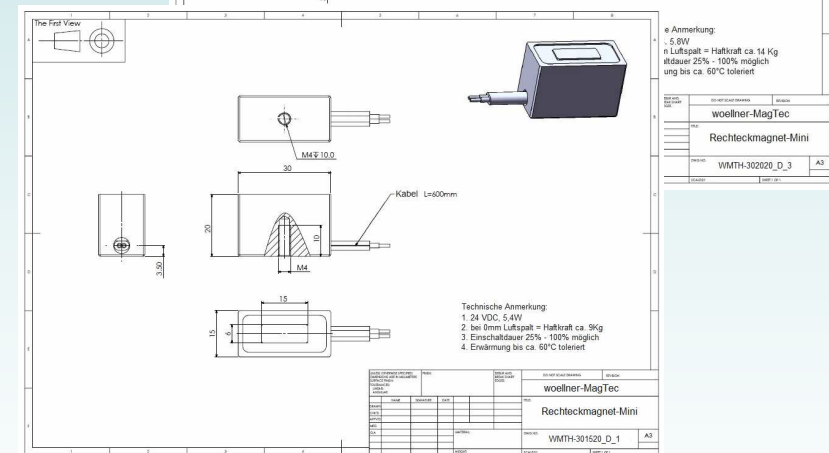
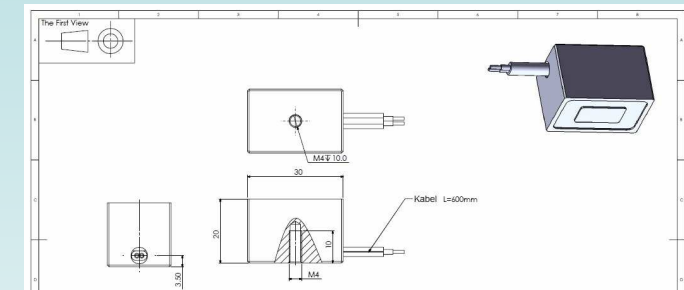

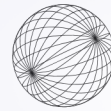

Overview of some products:

- Electromagnets (pressed, cast, cut)
 - round, square, lifting solenoids, others
- Magnets
 - Discs, blocks, rings, others
- Induction
 - Coils 1-layer, 2-layer, round, square, others
- Sensors
 - For: scanners, microelectronics, liquids, temperature, others

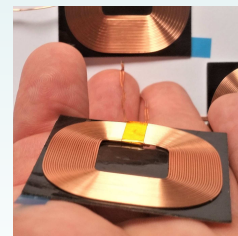
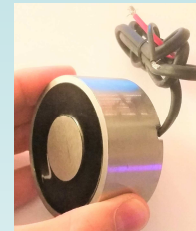

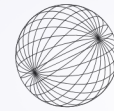

woellner-MagTec.
Zuverlässig. Robust.

Thanks a lot! Please contact us...

Internet: www.woellner-magtec.de

Email: info@woellner-magtec.de

Phone: +49 1525 3947 677

© woellner-MagTec., 2017 - 2020